

# BCO

## BEST CRAFT ORGANIZER STAMP CASE TOWER - SLIM



Quick-Fit Dowel (15)



Wood Dowel (16)



Cam Locks (19)

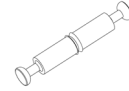

Short Extensions (2)



Shelf Pins (24)

Gold Screw (2)

Silver Screw (2)

Wall Anchor (2)

You will need: Phillips Screwdriver & Hammer

- 1.) Insert Quick Fit Dowels (4), Wood Dowels (4), and Cam Lock (1) into Panel BL.

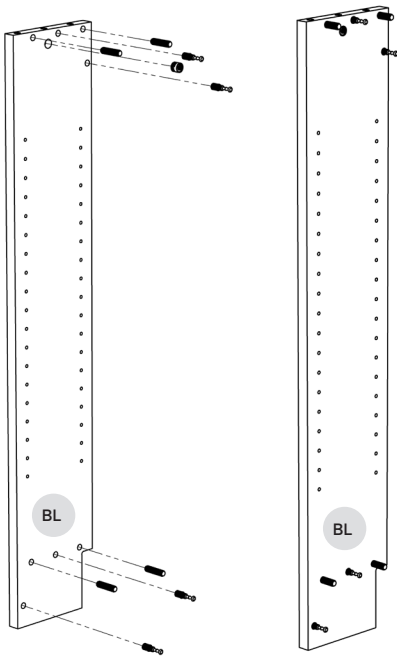

- 2.) Insert Quick Fit Dowels (1) and Cam Locks (5) into Panels A and B.

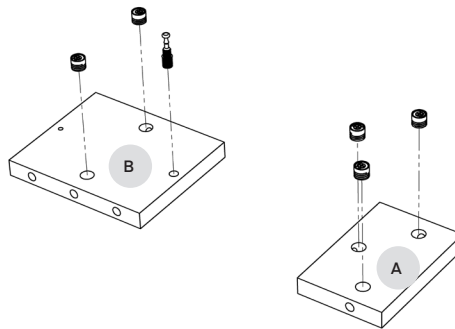

- 3.) Assemble Panel A to Panel B, tighten center Cam Lock.

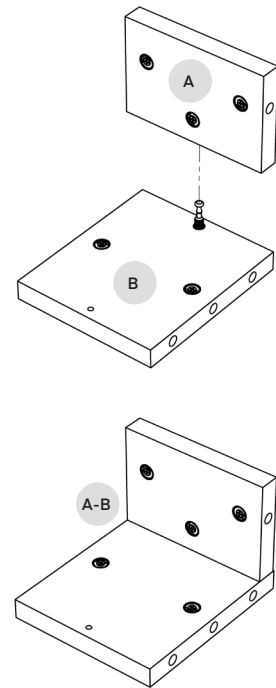

- 4.) Place A-B assembly on Panel BL, tighten Cam Locks.

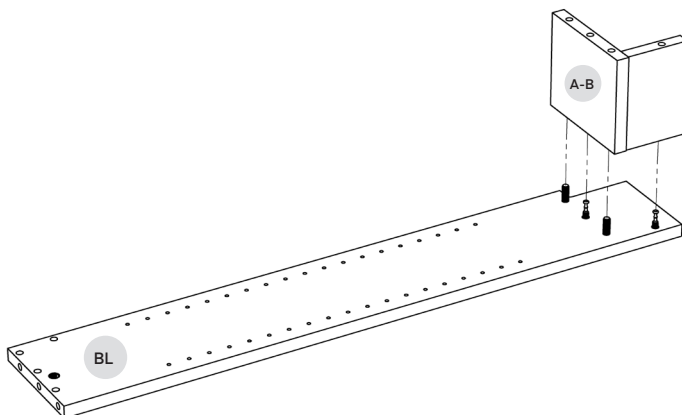

- 5.) Insert Quick Fit Dowel (1) and Cam Locks (5) into Panels C and D.

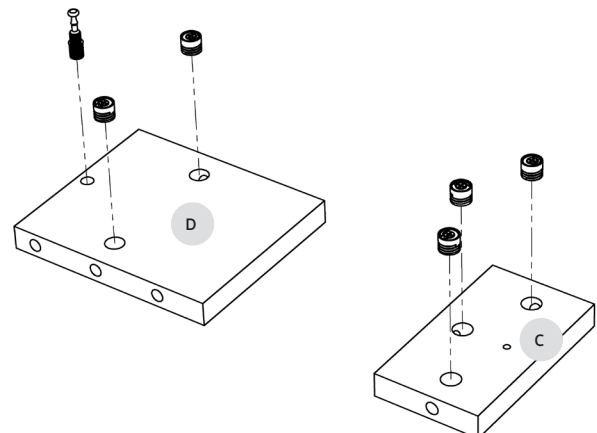

6.) Assemble Panel C to Panel D, tighten center Cam Lock.

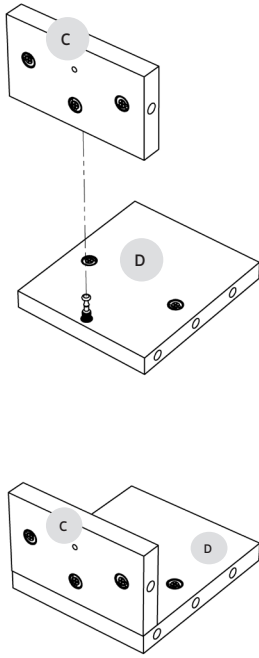

7.) Place C-D assembly on Panel BL, tighten Cam Locks.

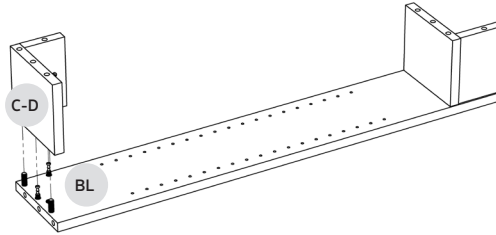

8.) Insert Quick Fit Dowels (4), Wood Dowels (4), and Cam Lock (1) into Panel BR.

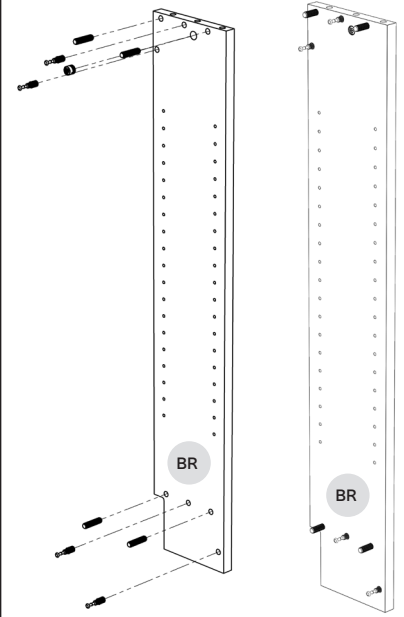

9.) Place Panel BR on assembly, tighten Cam Locks.

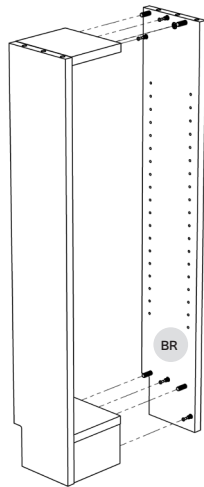

10.) Insert Wood Dowels (4) and Short Extensions (2).

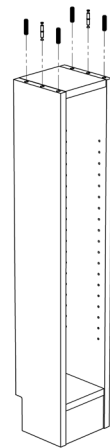

11.) Insert Quick Fit Dowels (2), Wood Dowels (2), and Cam Lock (1) into Panel TL.

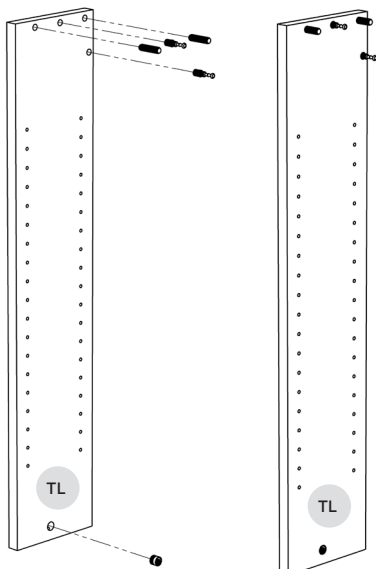

12.) Insert Quick Fit Dowels (1) and Cam Locks (5) into Panels C and D.

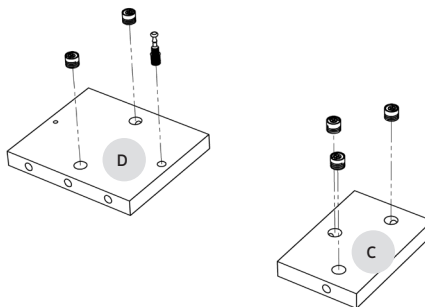

13.) Assemble Panel C to Panel D, tighten center Cam Lock.

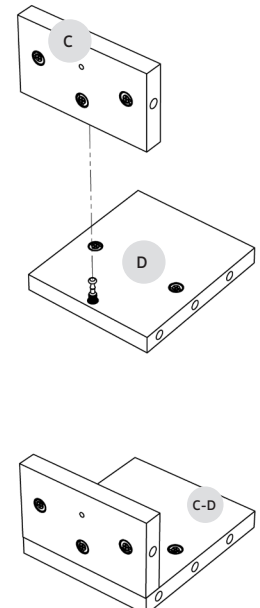

**14.)** Place C-D assembly on Panel TL, tighten Cam Locks.

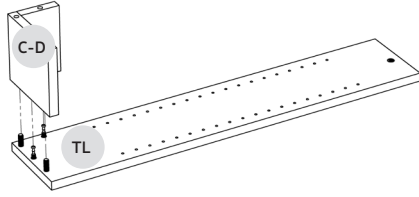

**15.)** Insert Quick Fit Dowel (2), Wood Dowels (2), and Cam Lock (1) into Panel TR.

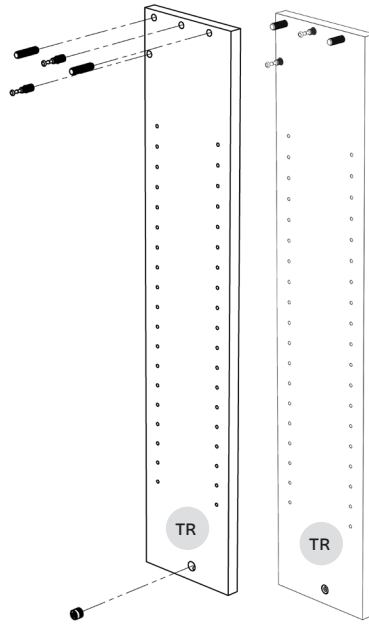

**16.)** Place Panel TR on assembly, tighten Cam Locks.

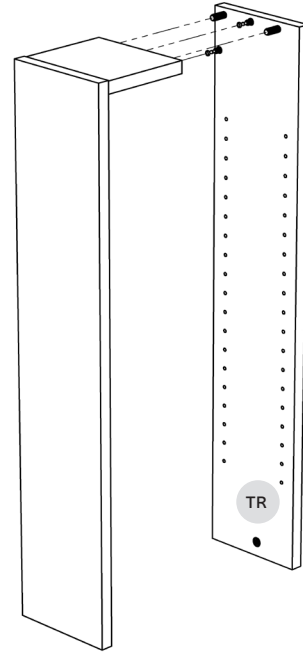

**17.)** Place upper section onto lower section, tighten Cam Locks.

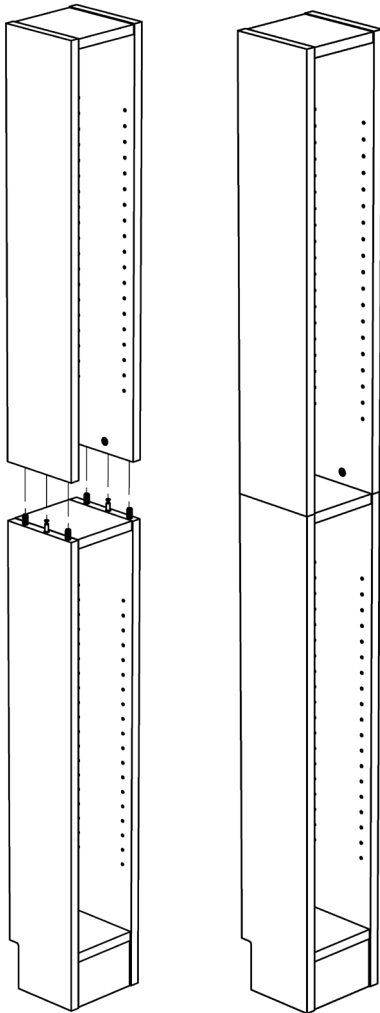

**18.)** Insert Shelf Pins. Locations shown provide the correct shelf spacing for stamp cases or Stamp-n-Storage for IKEA products. Mix and Match to your preference.

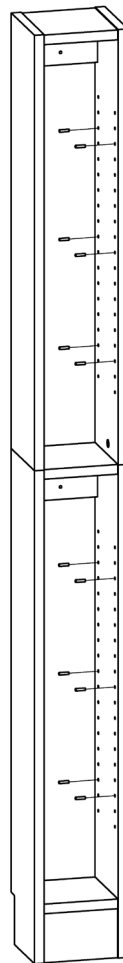

Stamp Case Configuration

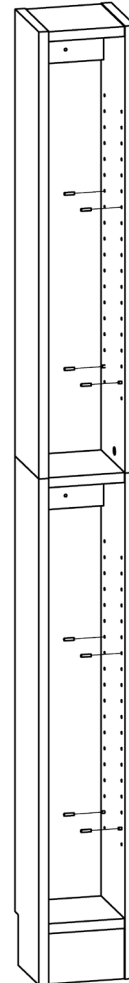

For IKEA Configuration

19.) Place Shelves on Shelf Pin.

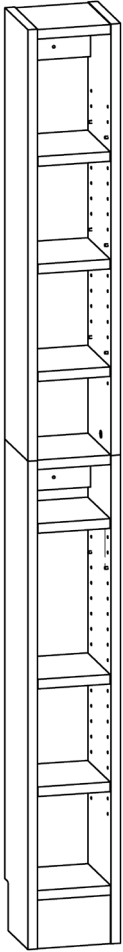

Stamp Case Configuration

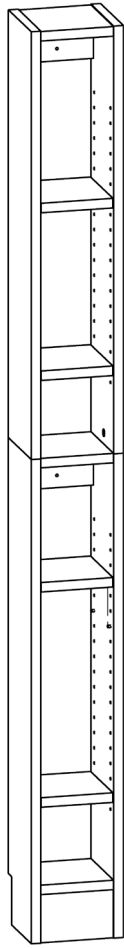

For IKEA Configuration



Required Step

20.) For safety you must secure your shelf to a wall. For best results, the long Gold Screws can secure your shelf to a wall stud. Or use the wall anchors provided for Sheetrock.

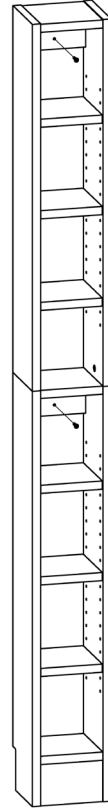

Stamp Case Configuration

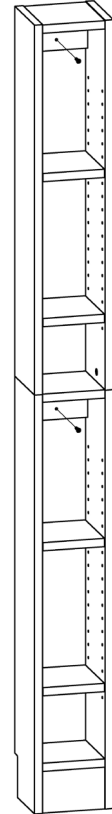

For IKEA Configuration